

IZYLUM LT



Lightweight, cost-effective solution for maximised energy savings in outdoor lighting

IZYLUM LT is an innovative street and road lighting solution that prioritises both energy efficiency and ease of use. It has been designed to offer the ultimate lighting solution for outdoor areas, providing high performance and functionality in a simple, user-friendly design.

With its three size options and various photometric technologies, it can be used for a wide range of applications, from city streets to public places, car parks, bike paths, bridges, roads, and motorways.

The IZYLUM LT universal fixation system allows easy, seamless switching between post-top and side-entry positions, eliminating the need for disconnection or additional effort. This feature ensures maximum flexibility and adaptability for any lighting application.

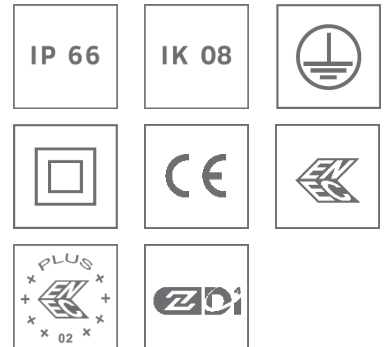

Concept

The IZYLUM LT luminaire range exemplifies a lean design approach, featuring a compact and efficient concept that uses minimal raw materials. This results in a cost-effective, sustainable lighting solution.

This luminaire is made of recyclable materials such as aluminium and glass, and is designed to promote circular economy principles through its accessible and replaceable components. This makes it easy to maintain and prolongs the life-cycle of the product.

The IZYLUM LT luminaire is available in three sizes, making it a versatile and efficient lighting solution for a wide range of applications, whether for city streets, public places, car parks, bike paths, bridges, roads or motorways.

The IZYLUM LT luminaires rely on advanced photometric technologies to precisely meet the unique demands of lighting projects and comply with local regulations. The LensoFlex®4 and HiFlex™ platforms offer flexible, energy-efficient photometric solutions that can be tailored to meet the specific lighting needs of any project while maximising savings and providing a quick return on investment.

IZYLUM LT features the versatile IzyFix universal fixation system, which allows easy post-top and side-entry installation on a variety of spigot sizes (Ø32mm, Ø42-48mm, Ø60mm and Ø76mm). The IzyFix system enables IZYLUM LT to be easily repositioned without the need to remove it from the pole, offering unparalleled flexibility in pole and bracket configurations. Additionally, for added convenience during installation and maintenance, the luminaire offers tool-free access to the gear compartment.

IZYLUM LT is a connected-ready luminaire that can be equipped with optional NEMA or Zhaga sockets, enabling it to easily integrate with various connected lighting systems, and providing greater adjustability and control.



IZYLUM LT is a cost-effective, energy-efficient lighting solution that offers the most optimised total cost of ownership in a compact design.



IZYLUM LT meets the requirements of the circular economy.



Available in three sizes with various photometric technologies, IZYLUM LT provides a solution for a wide range of lighting applications.



The versatile IzyFix system allows easy switching between post-top and side-entry positions, simplifying the ordering and installation process.

TYPES OF APPLICATION

- URBAN & RESIDENTIAL STREETS
- BRIDGES
- BIKE & PEDESTRIAN PATHS
- RAILWAY STATIONS & METROS
- CAR PARKS
- SQUARES & PEDESTRIAN AREAS
- ROADS & MOTORWAYS

KEY ADVANTAGES

- Cost-effective and efficient to maximise energy and maintenance savings
- Robust and recyclable materials
- Tool free access
- On-site adjustment from post-top to side-entry without disconnecting the luminaire from the pole thanks to IzyFix
- Zhaga-D4i certified
- Connected-ready
- HiFlex photometric engine designed for optimised energy efficiency
- LensoFlex®4 versatile solutions for high-end photometries maximising comfort and safety

IZYLUM LT | IZYLUM LT 1



IZYLUM LT | IZYLUM LT 2



IZYLUM LT | IZYLUM LT 3





LensoFlex®4

LensoFlex®4 maximises the heritage of the LensoFlex® concept with a very compact yet powerful photometric engine based upon the addition principle of photometric distribution. The number of LEDs in combination with the driving current determines the intensity level of the light distribution. With optimised light distributions and very high efficiency, this fourth generation enables the products to be downsized to meet application requirements with an optimised solution in terms of investment.

LensoFlex®4 optics can feature backlight control to prevent intrusive lighting, or a glare limiter for high visual comfort.

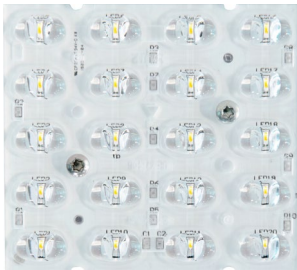

HiFlex™

The HiFlex platform is expertly designed to optimise energy efficiency. Its photometric engines feature high-power LEDs that deliver exceptional performance while consuming minimal energy, resulting in unmatched efficacy (lm/W).

Ideal for projects that require a streamlined approach to maximising lighting efficacy and achieving swift ROI, HiFlex is available in two versions: HiFlex 1, boasting 24 LEDs and HiFlex 2, equipped with 36 LEDs. Both variants are designed with the priorities of compactness, cost-effectiveness and high performance in mind.



Custom dimming profile

Intelligent luminaire drivers can be programmed with complex dimming profiles. Up to five combinations of time intervals and light levels are possible. This feature does not require any extra wiring.

The period between switching on and switching off is used to activate the preset dimming profile. The customised dimming system generates maximum energy savings while respecting the required lighting levels and uniformity throughout the night.

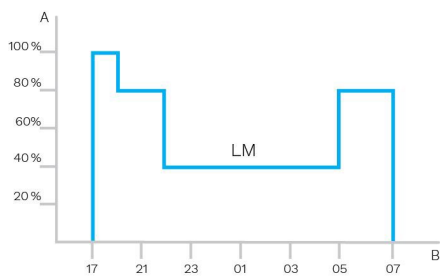

A. Dimming level | B. Time

The Schröder IzyFix patented high-pressure die-casted aluminium universal fixation system is an integral part of the luminaire mounted in the factory. The IzyFix system aims to fit needs worldwide by meeting IEC and ANSI 3G testing requirements. It is intended to simplify life for customers and installers in the process of purchasing and installing luminaires for various applications.

Best-in-class tilting range

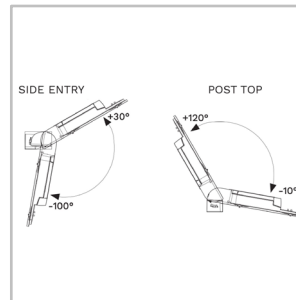

The IzyFix universal fixation system enables a best-in-class range of mounting angle of 130°*, to ensure maximum lighting performance for all kinds of road scenarios and offer the possibility of installing the luminaire in extreme situations as well. With a setting mark on the body and angles on the spigot, adjusting is carried out in 5° increments by loosening two screws. The wide tilting range enables more comfortable access to the gear

compartment during field maintenance.

*Depending on the size and shape of the luminaire, the inclination angle may be reduced. For more accurate information, always consult the installation sheets.

Variation for all poles

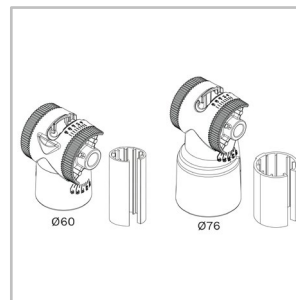

Due to the many different applications used worldwide, Schröder has created a range of fixation systems and reducers to satisfy all needs that might come up on the market.

	IzyFix Ø60mm	IzyFix Ø76mm
Ø32mm spigot	✓ (with reducer)	✓ (with reducer)
Ø42-48mm spigot	✓	✓ (with reducer)
Ø60mm spigot	✓	✓
Ø76mm spigot	✗	✓

From post-top to side-entry in one movement

The innovative design allows changing from a side-entry to a post-top position – even with luminaires ordered with factory pre-cablings – without any switching work on the fixation or disconnection from the pole. Therefore the type of mounting (horizontal or vertical) does not have to be considered when ordering. This unique feature also eases installation. After setting the correct position, an accessory is provided to cover the resulting space and ensure further protection of the luminaire.

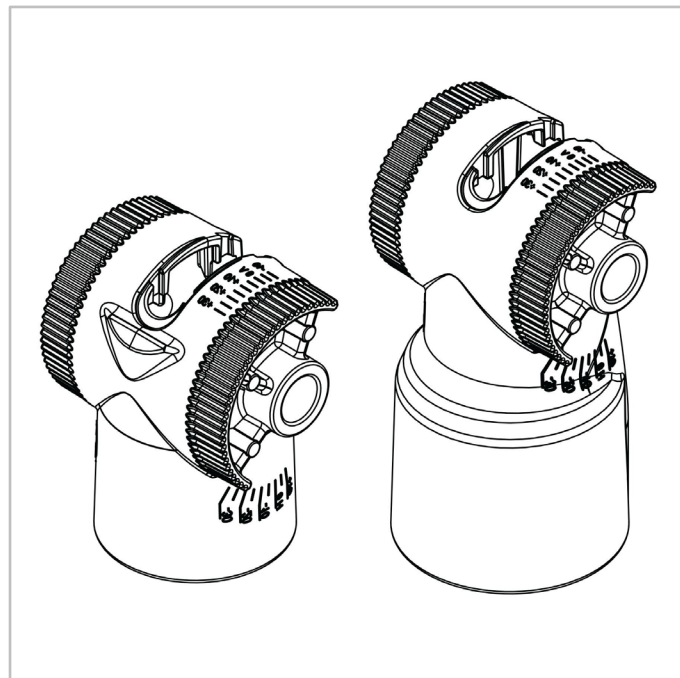

The Zhaga consortium joined forces with the DiiA and produced a single Zhaga-D4i certification that combines the Zhaga Book 18 version 2 outdoor connectivity specifications with the DiiA's D4i specifications for intra-luminaire DALI.

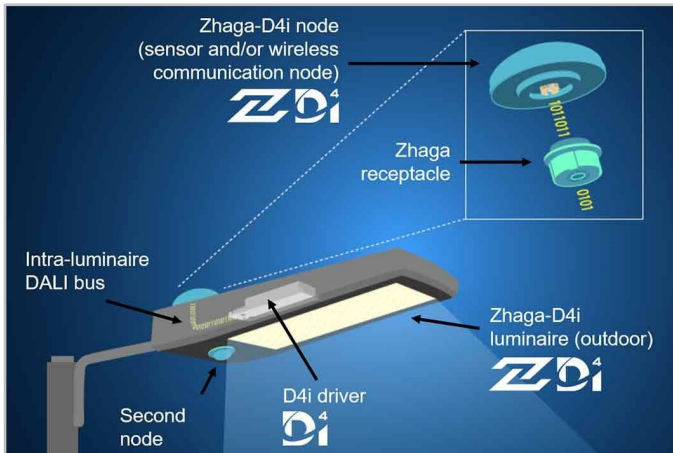

Standardisation for interoperable ecosystems



As a founding member of the Zhaga consortium, Schröder has participated in the creation of, and therefore supports, the Zhaga-D4i certification program and the initiative of this group to standardise an interoperable ecosystem. The D4i specifications take the best of the standard DALI2 protocol and adapt it to an intra-luminaire environment but it has certain limitations. Only luminaire mounted control devices can be combined with a Zhaga-D4i luminaire.

According to the specification, control devices are limited respectively to 2W and 1W average power consumption.

Certification program

The Zhaga-D4i certification covers all the critical features including mechanical fit, digital communication, data reporting and power requirements within a single luminaire, ensuring plug-and-play interoperability of luminaires (drivers) and peripherals such as connectivity nodes.

Cost-effective solution

A Zhaga-D4i certified luminaire includes drivers offering features that had previously been in the control node, like energy metering, which has in turn simplified the control device therefore reducing the price of the control system.

Schröder EXEDRA is the most advanced lighting management system on the market for controlling, monitoring and analysing streetlights in a user-friendly way.



Standardisation for interoperable ecosystems

Schröder plays a key role in driving standardisation with alliances and partners such as uCIFI, TALQ or Zhaga. Our joint commitment is to provide solutions designed for vertical and horizontal IoT integration. From the body (hardware) to the language (data model) and the intelligence (algorithms), the complete Schröder EXEDRA system relies on shared and open technologies. Schröder EXEDRA also relies on Microsoft Azure for cloud services, provided with the highest levels of trust, transparency, standards conformance and regulatory compliance.

Breaking the silos

With EXEDRA, Schröder has taken a technology-agnostic approach: we rely on open standards and protocols to design an architecture able to interact seamlessly with third-party software and hardware solutions. Schröder EXEDRA is designed to unlock complete interoperability, as it offers the ability to:

- control devices (luminaires) from other brands
- manage controllers and to integrate sensors from other brands
- connect with third-party devices and platforms

A plug-and-play solution

As a gateway-less system using the cellular network, an intelligent automated commissioning process recognises, verifies and retrieves luminaire data into the user interface. The self-healing mesh between luminaire controllers enables real-time adaptive lighting to be configured directly via the user interface. OWLET IV luminaire controllers, optimised for Schröder EXEDRA, operate Schröder's luminaires and luminaires from third parties. They use both cellular and mesh radio networks, optimising geographical coverage and redundancy for continuous operation.

Tailored experience

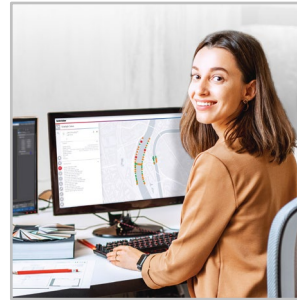

Schröder EXEDRA includes all advanced features needed for smart device management, real-time and scheduled control, dynamic and automated lighting scenarios, maintenance and field operation planning, energy consumption management and third-party connected hardware integration. It is fully configurable and includes tools for user management and multi-tenant policy that enables contractors, utilities or big cities to segregate projects.

A powerful tool for efficiency, rationalisation and decision making

Data is gold. Schröder EXEDRA brings it with all the clarity managers need to drive decisions. The platform collects massive amounts of data from end devices and, aggregates, analyses and intuitively displays them to help end-users take the right actions.

Protected on every side



Schröder EXEDRA provides state-of-the-art data security with encryption, hashing, tokenisation, and key management practices that protect data across the whole system and its associated services. The whole platform is ISO 27001 certified. It demonstrates that Schröder EXEDRA meets the requirements for establishing, implementing, maintaining and continually improving security management.

Mobile App: any time, any place, connect to your street lighting

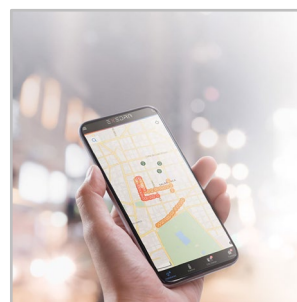

The Schröder EXEDRA mobile application offers the essential functionalities of the desktop platform, to accompany all types of operator on site in their daily effort to maximise the potential of connected lighting. It enables real-time control and settings, and contributes to effective maintenance.

With the PureNight concept, Schröder offers the ultimate solution for restoring the night sky without switching off cities, while maintaining safety and well-being for people and preserving wildlife. The PureNight concept guarantees that your Schröder lighting solution satisfies environmental laws and requirements. Well-designed LED lighting has the potential to improve the environment in all respects.

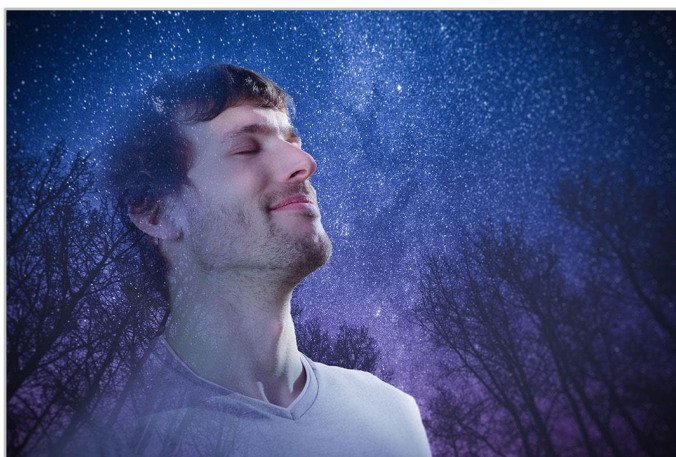

Direct the light only where it is wanted and needed

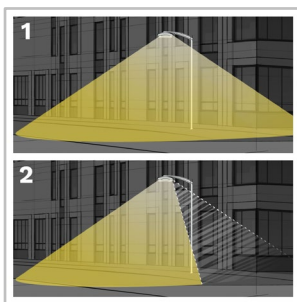

1. Without backlight
2. With backlight

Schröder is renowned for its expertise in photometry. Our optics direct light only where it is wanted and needed. However, light trespass behind the luminaire might be a key concern when it comes to protecting a sensitive wildlife habitat or avoiding intrusive lighting towards buildings. Our fully integrated backlight solutions easily address this potential risk.

Offer maximum visual comfort to people



Because of the lower installation height compared to road lighting, visual comfort is an essential aspect of urban lighting. Schröder designs lenses and accessories to minimise any type of glare (distracting, discomforting, disabling glare and blinding glare). Our design offices harness a range of possibilities to find the best solutions for each project and ensure that we provide a gentle light that delivers the best night-time experience.

Protect wildlife

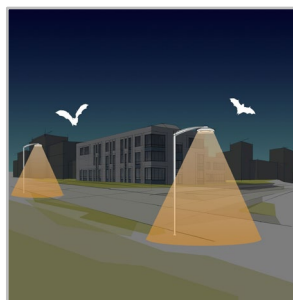

If not well designed, artificial lighting can badly affect wildlife. Blue light and excessive intensity can have a damaging effect on all types of life. Blue light radiation has the ability to suppress the production of melatonin, the hormone that contributes to the regulation of the circadian rhythm. It can also alter the behavioural patterns of animals including bats and moths, as it can change their movements towards or away from light sources. Schröder favours warm white LEDs with minimal blue light, combined with advanced control systems including sensors. This enables permanent adaptation of the lighting to the real needs of the moment, minimising disturbance to the fauna and flora.

Get the starry sky back



The Upward Light Ratio (ULR) and Upward Light Output Ratio (ULOR), the latter taking the flux from the luminaire into account, provide information on the percentage of light emitted towards the sky. This Schröder range of luminaires minimises or eliminates (depending on the options) upward-directed light flux. It complies with strict international and local requirements.

GENERAL INFORMATION

Recommended installation height	4m to 15m 13' to 49'
Circle Light label	Score ≥ 90 - The product fully meets circular economy requirements
Driver included	Yes
CE mark	Yes
ENEC certified	Yes
ENEC+ certified	Yes
Zhaga-D4i certified	Yes
Testing standard	EN 60598-1 EN 60598-2-1 EN 62262

HOUSING AND FINISH

Housing	Aluminium
Optic	PMMA
Protector	Tempered glass
Housing finish	Polyester powder coating
Standard colour(s)	AKZO grey 900 sanded
Tightness level	IP 66
Impact resistance	IK 08
Vibration test	Compliant with ANSI C 136-31 standard, 3G load Compliant with modified IEC 68-2-6 (0.5G)
Access for maintenance	Tool-less access to gear compartment

OPERATING CONDITIONS

Operating temperature range (Ta)	-30°C up to +55°C / -22°F up to 131°F with wind effect
----------------------------------	--

· Depending on the luminaire configuration. For more details, please contact us.

ELECTRICAL INFORMATION

Electrical class	Class I EU, Class II EU
Nominal voltage	120-277V – 50-60Hz 220-240V – 50-60Hz
Surge protection options (kV)	10
Electromagnetic compatibility (EMC)	EN 55015 / EN 61000-3-2 / EN 61000-3-3 / EN 61547
Control protocol(s)	1-10V, DALI
Control options	AmpDim, Bi-power, Custom dimming profile, Remote management
Socket	Zhaga (optional) NEMA 7-pin (optional)
Associated control system(s)	Schröder EXEDRA

OPTICAL INFORMATION

LED colour temperature	2200K (Warm White WW 722) 2700K (Warm White WW 727) 3000K (Warm White WW 730) 3000K (Warm White WW 830) 4000K (Neutral White NW 740)
Colour rendering index (CRI)	>70 (Warm White WW 722) >70 (Warm White WW 727) >70 (Warm White WW 730) >80 (Warm White WW 830) >70 (Neutral White NW 740)
ULOR	0%
ULR	0%

· ULOR may be different according to the configuration. Please consult us.

· ULR may be different according to the configuration. Please consult us.

LIFETIME OF THE LEDS @ TQ 25°C

All configurations	100,000h - L95
--------------------	----------------

· Lifetime may be different according to the size/configurations. Please consult us.

DIMENSIONS AND MOUNTING

AxBxC (mm inch)	IZYLUM LT 1 : 555x100x242 21.9x3.9x9.5 IZYLUM LT 2 : 646x100x242 25.4x3.9x9.5 IZYLUM LT 3 : 616x100x371 24.3x3.9x14.6
Weight (kg lbs)	IZYLUM LT 1 : 3.5-5.1 7.7-11.2 IZYLUM LT 2 : 4.0-5.6 8.8-12.3 IZYLUM LT 3 : 6.3-8.7 13.9-19.1
Aerodynamic resistance (CxS)	IZYLUM LT 1 : 0.03 IZYLUM LT 2 : 0.03 IZYLUM LT 3 : 0.04
Mounting possibilities	Side-entry slip-over – Ø32mm Side-entry slip-over – Ø42mm Side-entry slip-over – Ø48mm Side-entry slip-over – Ø60mm Side-entry slip-over – Ø76mm Post-top slip-over – Ø32mm Post-top slip-over – Ø42mm Post-top slip-over – Ø48mm Post-top slip-over – Ø60mm Post-top slip-over – Ø76mm

· For more information about mounting possibilities, please consult the installation sheet.

· Dimensions given with Ø60mm spigot (side-entry mounting)

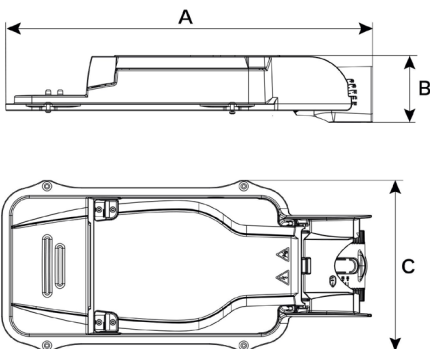

IZYLUM LT | Slip-over mounting for Ø32-60mm spigot - 2xM10 screws

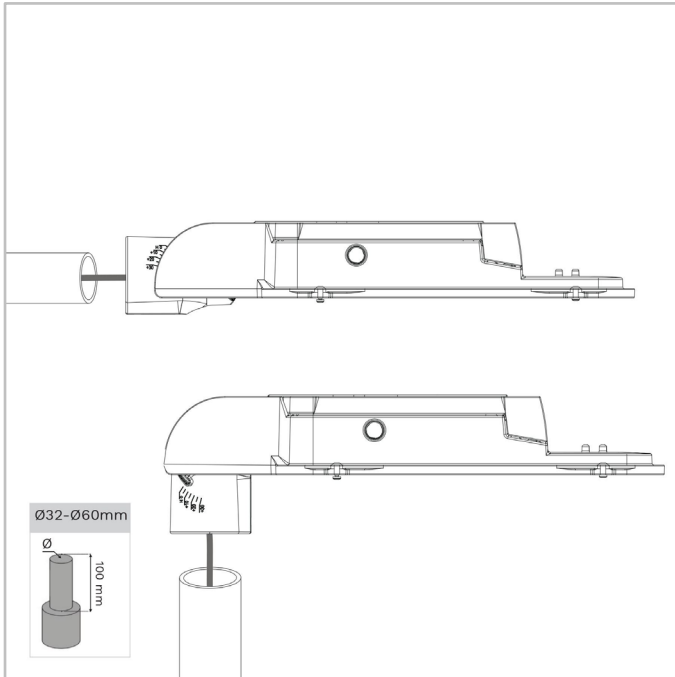

IZYLUM LT | Slip-over mounting for Ø32-76mm spigot - 2xM10 screws

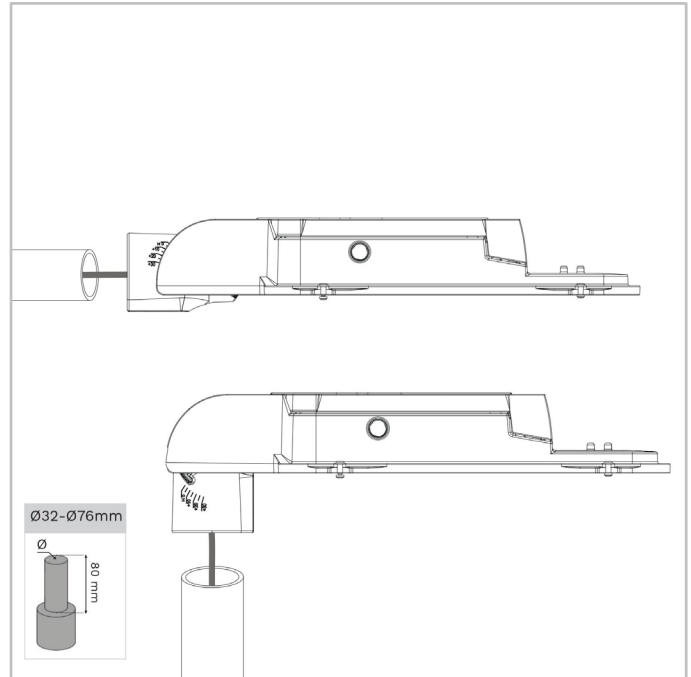

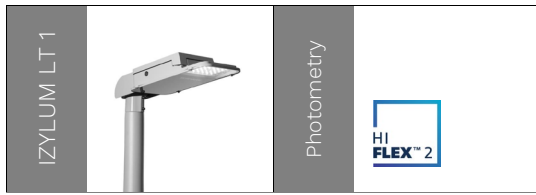

Number of LEDs	Luminaire output flux (lm)								Power consumption (W)		Luminaire efficacy (lm/W)
	Warm White WW 722		Warm White WW 727		Warm White WW 730		Neutral White NW 740				
	Min	Max	Min	Max	Min	Max	Min	Max	Min	Max	Up to
36	1900	7100	2200	8000	2300	8300	2500	9000	15	54	172

Tolerance on LED flux is $\pm 7\%$ and on total luminaire power $\pm 5\%$

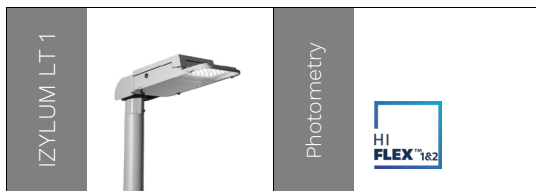

Number of LEDs	Luminaire output flux (lm)								Power consumption (W)		Luminaire efficacy (lm/W)
	Warm White WW 722		Warm White WW 727		Warm White WW 730		Neutral White NW 740				
	Min	Max	Min	Max	Min	Max	Min	Max	Min	Max	Up to
24	1200	6300	1400	7200	1400	7400	1600	8000	11	52	166

Tolerance on LED flux is $\pm 7\%$ and on total luminaire power $\pm 5\%$

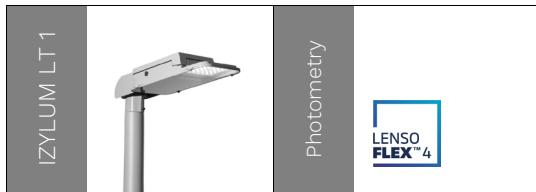

Number of LEDs	Luminaire output flux (lm)										Power consumption (W)		Luminaire efficacy (lm/W)
	Warm White WW 722		Warm White WW 727		Warm White WW 730		Warm White WW 830		Neutral White NW 740				
	Min	Max	Min	Max	Min	Max	Min	Max	Min	Max	Min	Max	Up to
10	700	3500	700	3700	800	4100	700	3800	800	4300	7	36	152
20	2100	6800	2200	7100	2400	7800	2200	7300	2500	8200	20	68	157
25	2000	8000	2100	8400	2300	9200	2100	8600	2500	10000	16	87	168

Tolerance on LED flux is ± 7% and on total luminaire power ± 5 %

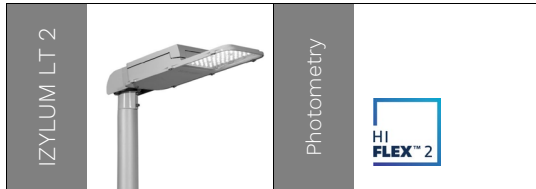

Number of LEDs	Luminaire output flux (lm)								Power consumption (W)		Luminaire efficacy (lm/W)
	Warm White WW 722		Warm White WW 727		Warm White WW 730		Neutral White NW 740				
	Min	Max	Min	Max	Min	Max	Min	Max	Min	Max	Up to
72	4000	10600	4500	12000	4600	12500	5000	13400	27	76	191

Tolerance on LED flux is ± 7% and on total luminaire power ± 5 %

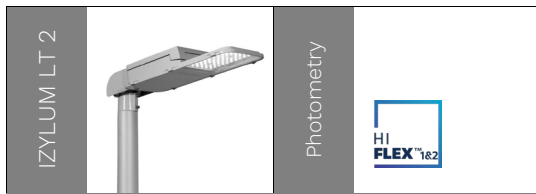

Number of LEDs	Luminaire output flux (lm)								Power consumption (W)		Luminaire efficacy (lm/W)
	Warm White WW 722		Warm White WW 727		Warm White WW 730		Neutral White NW 740		Min	Max	Up to
	Min	Max	Min	Max	Min	Max	Min	Max			
48	2500	12600	2900	14300	3000	14800	3200	16000	19	104	174

Tolerance on LED flux is $\pm 7\%$ and on total luminaire power $\pm 5\%$

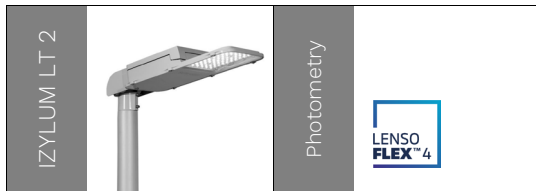

Number of LEDs	Luminaire output flux (lm)										Power consumption (W)		Luminaire efficacy (lm/W)
	Warm White WW 722		Warm White WW 727		Warm White WW 730		Warm White WW 830		Neutral White NW 740		Min	Max	Up to
	Min	Max	Min	Max	Min	Max	Min	Max	Min	Max			
30	2200	8400	2300	8700	2500	9600	2300	9000	2600	10100	18	73	172
40	2900	11100	3100	11600	3300	12700	3100	11900	3500	13400	23	98	182
50	4000	11500	4200	12000	4600	13100	4300	12400	4800	14400	28	98	186

Tolerance on LED flux is $\pm 7\%$ and on total luminaire power $\pm 5\%$

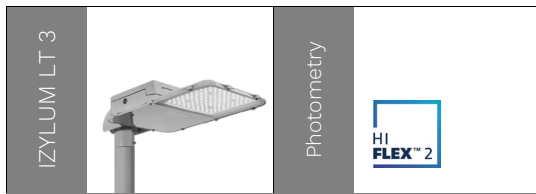

Number of LEDs	Luminaire output flux (lm)								Power consumption (W)		Luminaire efficacy (lm/W)
	Warm White WW 722		Warm White WW 727		Warm White WW 730		Neutral White NW 740				
	Min	Max	Min	Max	Min	Max	Min	Max	Min	Max	Up to
108	6000	24500	6800	27700	7000	28800	7600	31000	43	192	180
144	8000	16800	9100	18900	9400	19700	10100	21200	54	117	189

Tolerance on LED flux is $\pm 7\%$ and on total luminaire power $\pm 5\%$

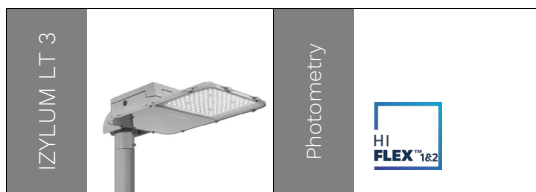

Number of LEDs	Luminaire output flux (lm)								Power consumption (W)		Luminaire efficacy (lm/W)
	Warm White WW 722		Warm White WW 727		Warm White WW 730		Neutral White NW 740				
	Min	Max	Min	Max	Min	Max	Min	Max	Min	Max	Up to
72	3800	17700	4300	20000	4500	20800	4900	22400	27	150	185
96	5100	24700	5800	27800	6000	29000	6500	31200	38	209	175

Tolerance on LED flux is $\pm 7\%$ and on total luminaire power $\pm 5\%$

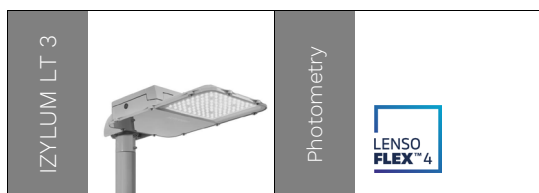

Number of LEDs	Luminaire output flux (lm)										Power consumption (W)		Luminaire efficacy (lm/W)
	Warm White WW 722		Warm White WW 727		Warm White WW 730		Warm White WW 830		Neutral White NW 740				
	Min	Max	Min	Max	Min	Max	Min	Max	Min	Max	Min	Max	Up to
50	3700	14600	3800	15200	4200	16700	3900	15700	4400	17700	30	139	174
60	4400	17500	4600	18300	5000	20000	4700	18900	5300	21200	37	165	170
70	5100	17000	5400	17800	5900	19500	5500	18300	6200	20600	44	144	166
75	6200	17800	6400	18600	7100	20300	6600	19100	7500	22200	45	154	177
80	5900	19500	6100	20300	6700	22200	6300	20900	7100	23600	46	164	180
100	8200	19000	8600	19800	9400	21700	8800	20400	9900	23700	57	151	185

Tolerance on LED flux is $\pm 7\%$ and on total luminaire power $\pm 5\%$

